



Spina mobile Plug



Art.
300618B

**Spina Schuko 90°
Doppio contatto
di terra
2P+T 16A~ 250V**



Dimensioni: 43x36xh52 mm
Size:

Spina Schuko 16A~ 250V
Schuko plug 16A~ 250V

Colori: Bianco
Colours: White

**Fermacavo a vite
Corpo in polimero
Passacavo morbido
Spinotti in ottone nichelato**

*Cable clamp screw
Polymer body
fairlead soft
Nickel-plated brass pins*

NORME: CEI 23-50



Scatolo con stampa in quadricromia
Giftbox 4 colours

8,0cm

20,0cm

20,0cm

Etichetta
Label

Scatolo contiene 5 buste trasparente da 5 pezzi
Giftbox contain 5 transparent bag with 5 plug

5 pezzi per ogni busta
Bag 5 pieces

Etichetta
Label

Busta trasparente
Transparent bag

Export Carton/PCS

Bar Code:
Position 4 sides
in the upper left

300618B 
8033726 880801

**Lateral Sides
Shipping Mark:**

 **Poliplast**
P/I NO.: _____
Codice: 300618
QTY: 300 PCS
CTN NO.: _____
Made in P.R.C.

**Central Sides
Shipping Mark:**

 **Poliplast**
Codice: 300618
Code: 300618
Color: _____
QTY: 300 PCS

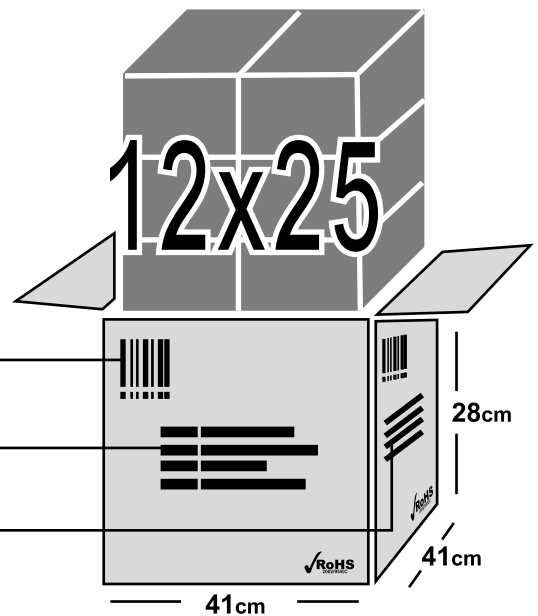

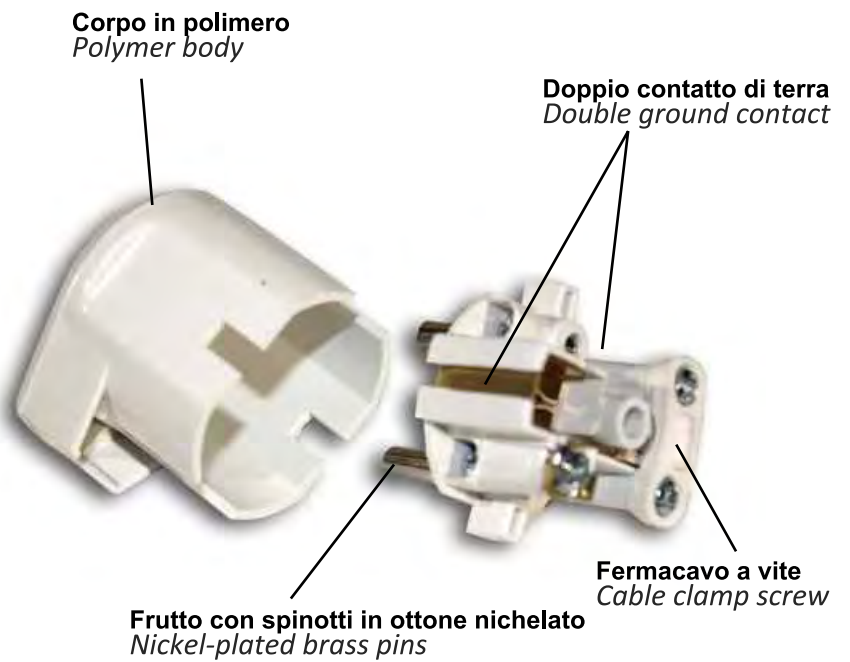
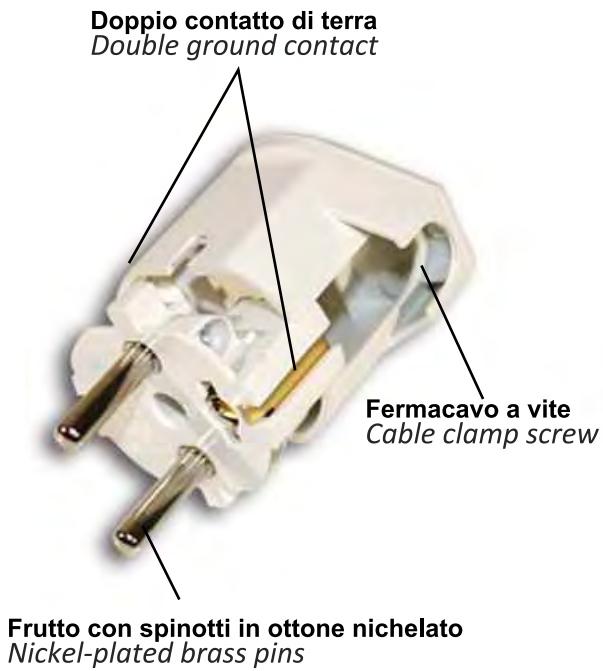

Misure
Measures

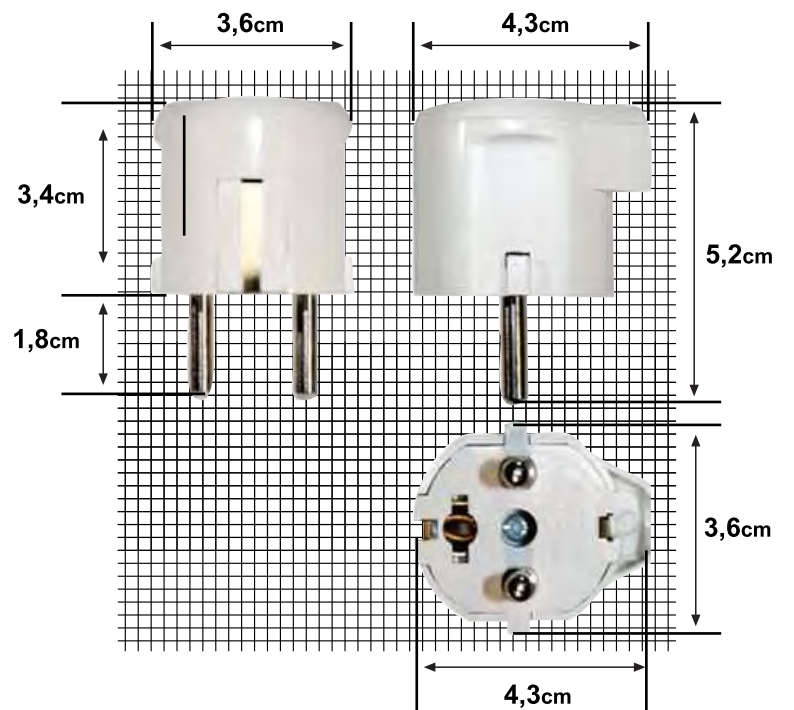
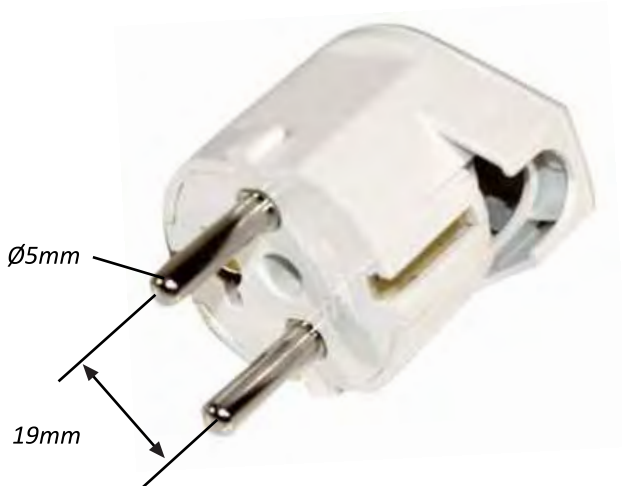

Art. 300618B
70x50 mm
Etichetta per lo scatolo
Label for box

Codice: 300618B	
Colore: <input type="checkbox"/>	
Descrizione: Spina Schuko 90° 2P+T 16A 250V~ Norme: CEI 23-50	
Pezzi: 25	
Made in P.C.R.	 8 033726 880801

	
Codice: 300618B	
Colore: Bianco	
Descrizione: Spina Schuko 90° 2P+T 16A 250V~ Norme: CEI 23-50	
Pezzi: 5	
Made in P.C.R.	 8 033726 880801

60x40 mm
Etichetta per la busta
Label for bag



Poliplast srl
Direzione e Uffici Amministrativi:
 Via Oliveto Scammacca, 7/c
 95127 Catania (Italy)
 Tel. +39 095.7357530 pbx
 Fax +39 095.7139988
 www.poliplastsrl.com - info@poliplastsrl.com

Poliplast
Piattaforma Logistica:
 via Crocifisso 67
 95121 Catania

Cap. Soc. Euro 103.000,00
 P.Iva 02738740873



DICHIARAZIONE DI CONFORMITÀ

La Ditta :

Poliplast S.r.l.
 Via Oliveto Scammacca 7/C
 95127 Catania
 Italia

Dichiara sotto la propria responsabilità che i prodotti contrassegnati con i codici:

300618

al quale questa dichiarazione si riferisce è conforme alle seguenti norme:

- NORMA CEI 23-50-II ed.2007
- EN 60947-1:2004

E quindi rispondente ai requisiti essenziali delle direttive nazionali.

Catania, 14 gennaio '15

